

Data Sheet



Article number: 12858100040860

Description: KLEE-coil 858 100 040.860
M4 Brass

Measures

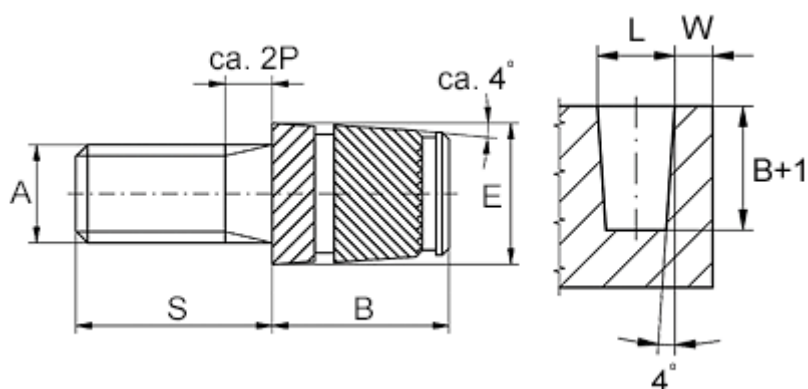

Male thread A	= M4x0,7
Min distance to edge W	= 2.0
Mounting length B	= 7.5
Outer diameter E	= 6.0
Pin length S	= 16
Recommended bore diameter W +0.1	= 5.8